

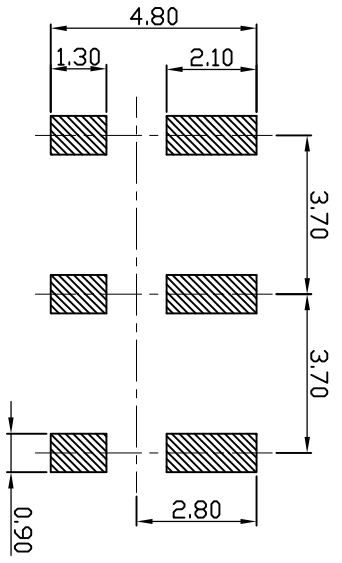

REV.	EQN. NO.	MODIFY CONTENT	DATE
A		NEW	2016/12/09

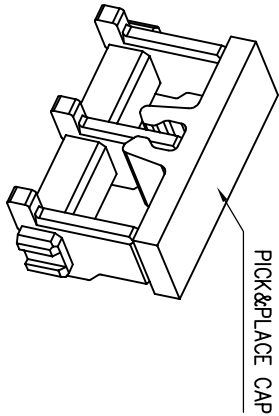
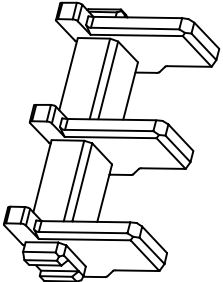
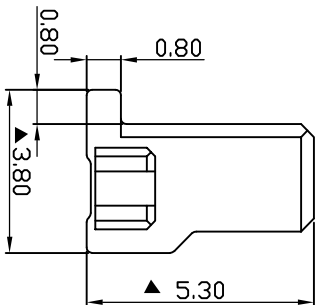
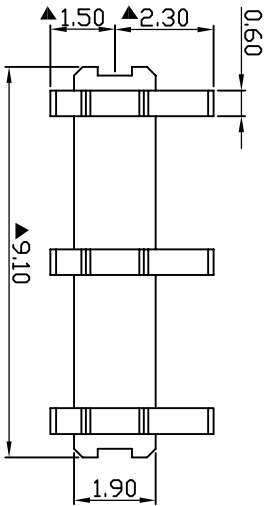
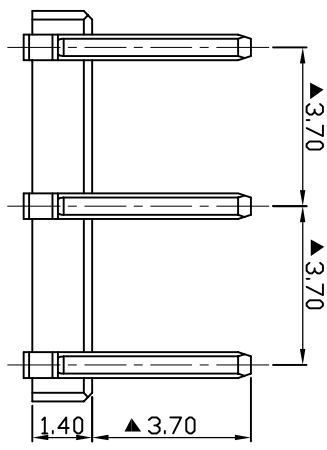

RECOMMENDED PCB LAYOUT  
(TOLERANCE: ±0.05)

- NOTES:
1. INTERPRET DRAWING PER ANSI Y14.5M-1994.
  2. MATERIAL AND FINISH  
HOUSING: HIGH-TEMP. THERMOPLASTIC, UL94V-0-BLACK.  
CONTACT: COPPER ALLOY, T=0.50mm.  
GOLD FLASH PLATING OVER 50μ" NICKEL ON CONTACT AREA.
  3. "▲" AS THE FOCUS CONTROL SIZE.

GENERAL TOLERANCE		DWG NO.	APPD:		WIND	Scale
X.±0.45	X.±1.5°	JYSA0508-001	CHKD:			1:1
X.±0.35	X.±1.2°	BATTERY 3PIN CONNECTOR HS.3 班 (NOKIA 8900)	DR:			UNIT
.XX±0.25	.XX±1°	Part NO.	Date	2016/12/09		mm
.XXX±0.15	.xxx±0.5°					
SHEET	1/1					

 杰宇森电子有限公司  
JIE YU SEN ELECTRONIC CO., LTD.