

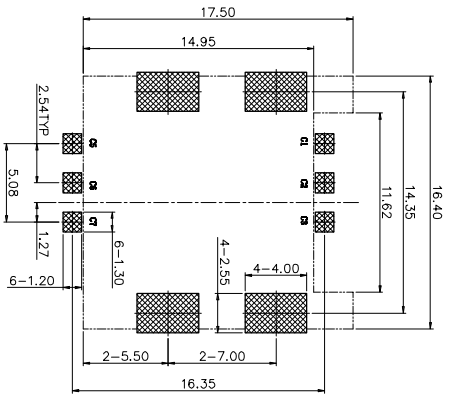

REV.	ECN NO.	MODIFY CONTENT	DATE
A		NEW	2014/10/31

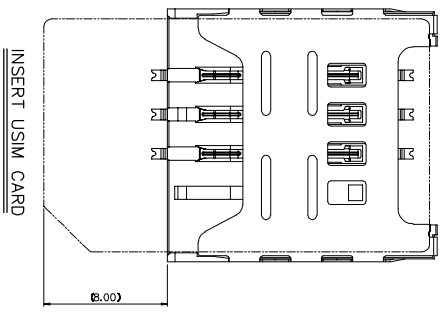
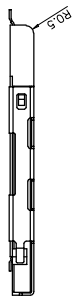
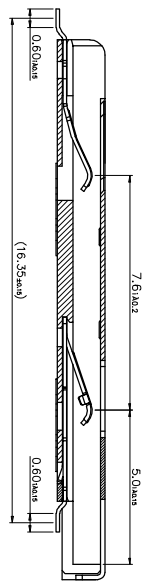
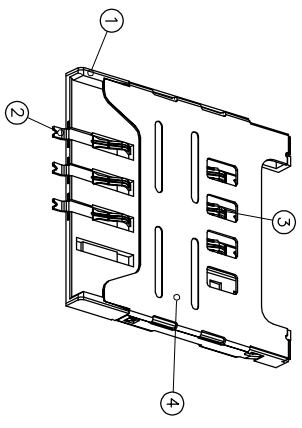
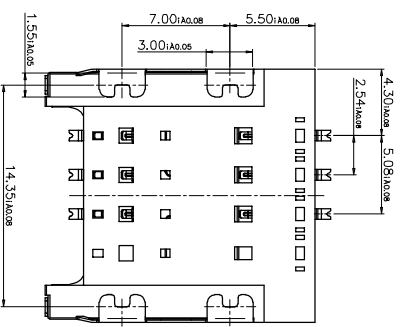
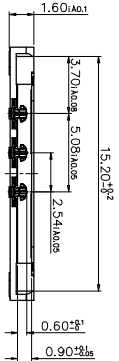
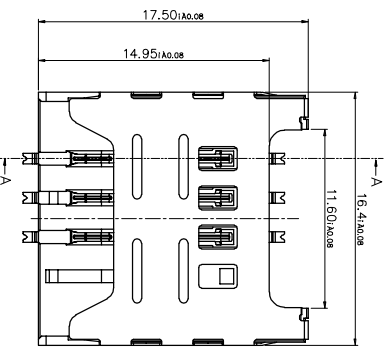
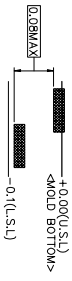

*Note:
 1. Plating
 - CONTACT
 : Contact Area- Au 0.3μm Min over Ni 1.0~5.0μm.
 : Lead Area- Au 0.05μm Min over Ni 0.2~0.3μm
 - Mead Cover: Ni: 0~5.0μm.
 2. ☆ = C:1.0
 - CONTACT: 0.08MAX
 - METAL COVER: 0.08MAX

4	METAL COVER	SUS304	Note	10.15
3	CONTACT-B	CS210	Note	10.12
2	CONTACT-A	CS210	Note	10.12
1	HOUSING	LCP	Block Color	UL94V-0
	NO. DESCRIPTION	Material	Finish	Remarks

GENERAL TOLERANCE		DWG NO.	JYSA0917-001	APPD:	WIND	Scale	1:1
X:±0.45	X:±5°	Title	SIM CARD 1.6H 6P FOR CUSTOMER	CHKD:		UNIT	mm
.X±0.35	.X°±2°	Part NO.	JYS-SIM160-068	DR:			
.XX±0.25	.XX°±1°			Date	2014/10/31		
.XXX±0.15	.XXX°±0.5°						
SHEET	1/1						

 杰宇森电子有限公司
 JIE YU SEN ELECTRONIC CO., LTD.