

REV.	ECN.NO.	MODIFY CONTENT	DATE
B		MODIFY	2015/04/11

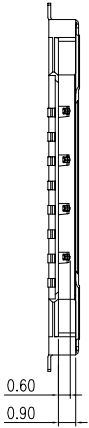

PIN NO.	PIN NAME
C1	VCC
C2	RST
C3	CLK
C4	Reserved
C5	GND
C6	VPP
C7	I/O
C8	Reserved

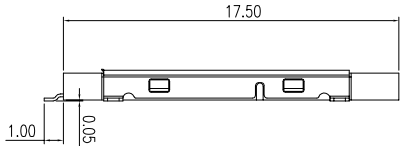
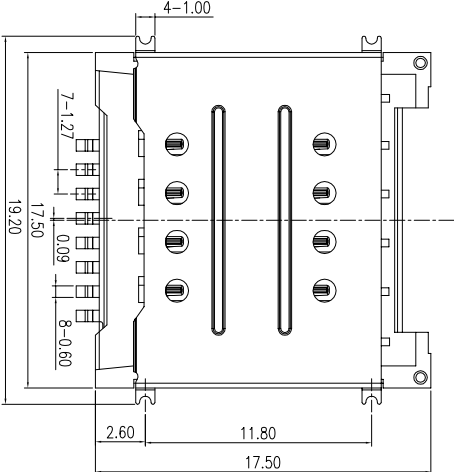
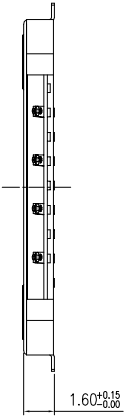
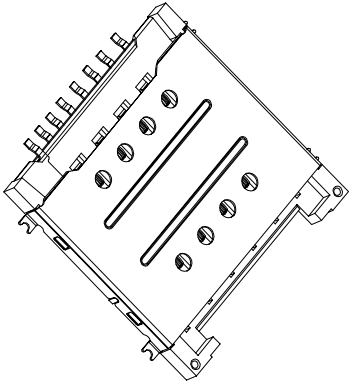
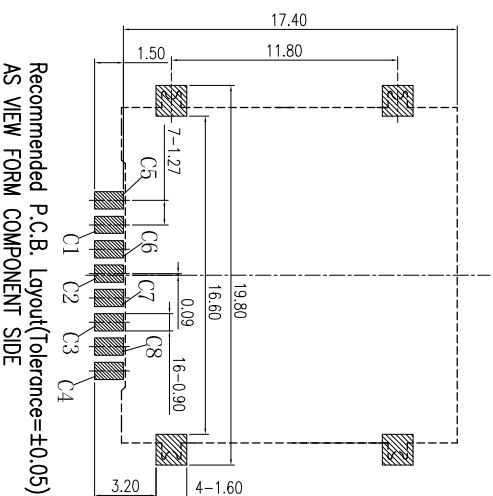
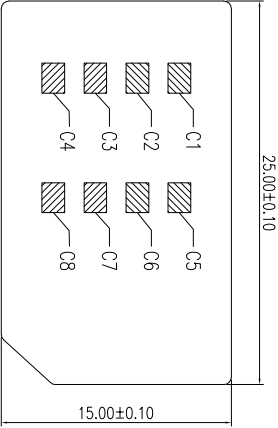

NOTES:
 1. MATERIAL
 HOUSING: THERMOPLASTIC UL94V-0; COLOR: BLACK
 CONTACT: COPPER ALLOY
 SHELL: STAINLESS STEEL
 2. FINISH
 CONTACT: NICKEL UNDERPLATED AND GOLD PLANTING
 OVER ALL.
 OR NICKEL UNDERPLATED AND GOLD PLANTING
 ON CONTACT AREA; Tin PLANTING ON SOLDER AREA
 SHELL: NICKEL UNDERPLATED AND GOLD PLANTING ON SOLDER AREA.

GENERAL TOLERANCE		图号	JYSA1504-001	设计	Ratio: x:n	比例	1:1
X.±0.35	X.±5°	品名	1.6H SIMM CARD 8PIN	审核		单位	mm
X.±0.25	X.±2°	料号	JYS-SM160-165	核准		视角	AO
.XX±0.15	.xx±1°	日期	2015/03/16	版本			
.XXX±0.05	.xxx±0.5°	页号	1/1				

JYS 杰宇森电子有限公司
 JIE YU SEN ELECTRONIC CO., LTD.